

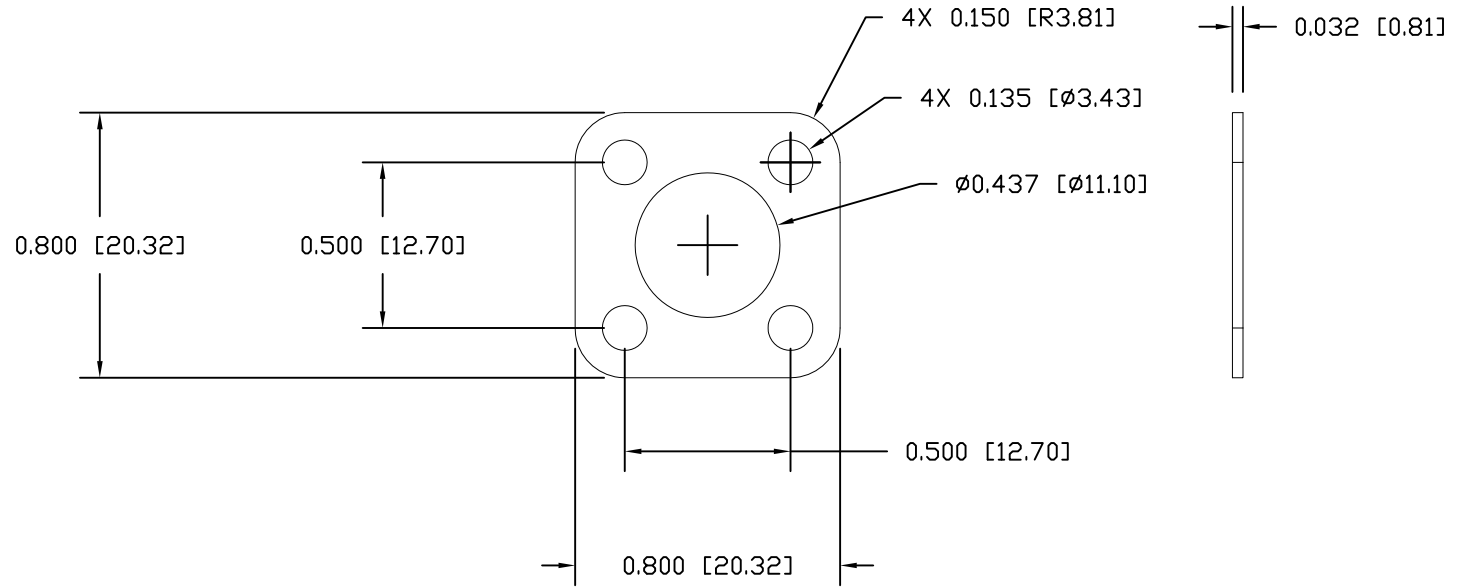



REVISIONS				
ZONE	REV	DESCRIPTION	DATE	APPROVED



<b>Tolerances:</b> Hole to Hole Centerline : +/- 0.010" Center Hole Diameter : + 0.020" / -0.0" Overall outside : +/- 0.015" Mounting Hole Diameter : +/- 0.010"	DRAWN	DATE	 252 Brighton Road, Andover NJ 07821 PH: 973-786-5000 FAX: 973-786-5546		
	S.ACKERMAN	2Q2015			
	CHECKED		<b>CONNECTOR GASKET</b>		
QA					
MFG		SIZE	CAGE	DWG NO.	REV
APPROVED		<b>A</b>	27565	M83528/004X035	<b>F</b>
SCALE			SHEET		1 OF 1

