

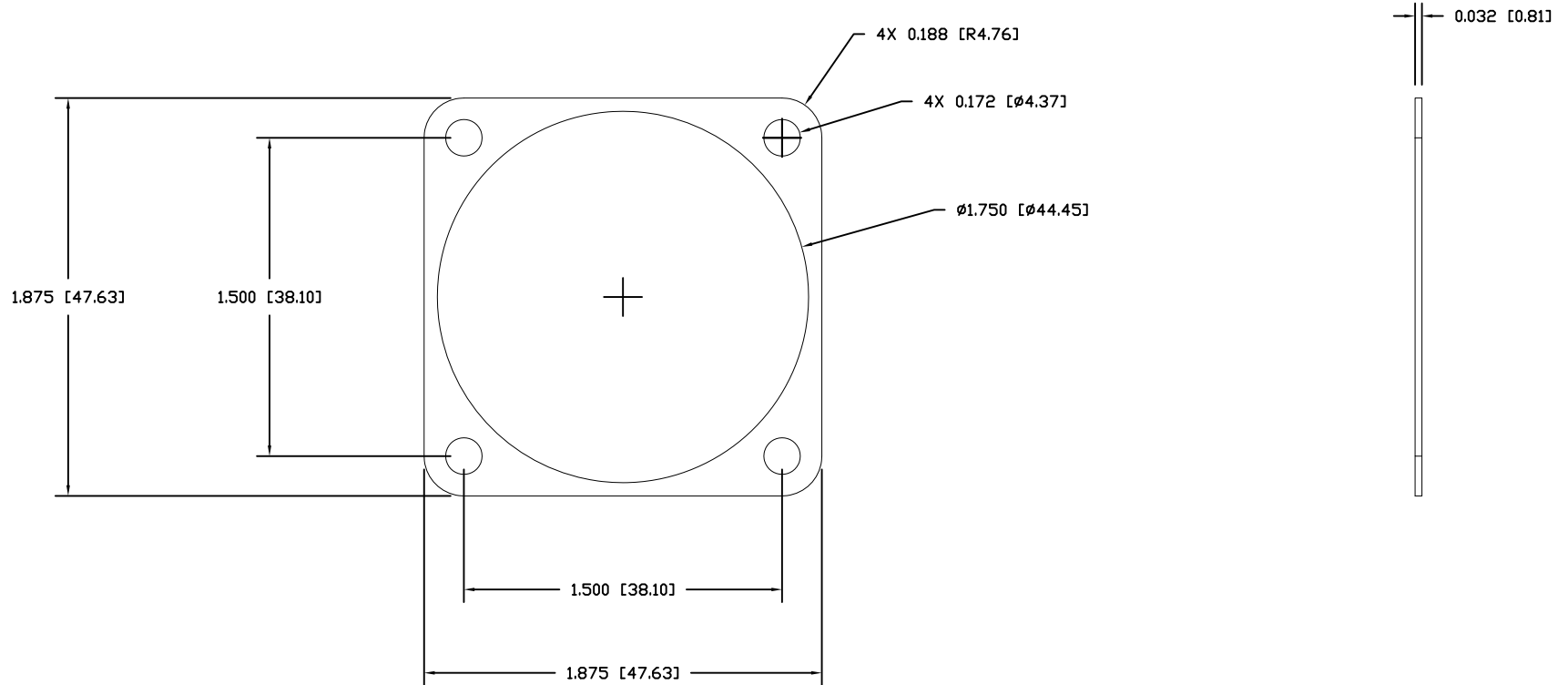



REVISIONS				
ZONE	REV	DESCRIPTION	DATE	APPROVED



<b>Tolerances:</b> Hole to Hole Centerline : +/- 0.010" Center Hole Diameter : + 0.020" / -0.0" Overall outside : +/- 0.015" Mounting Hole Diameter : +/- 0.010"	DRAWN <b>S.ACKERMAN</b>	DATE <b>2Q2015</b>	 252 Brighton Road, Andover NJ 07821 PH: 973-786-5000 FAX: 973-786-5546			
	CHECKED				<b>CONNECTOR GASKET</b>	
	QA					
	MFG		SIZE <b>A</b>	CAGE <b>27565</b>	DWG NO. <b>M83528/004X028</b>	REV <b>F</b>
	APPROVED		SCALE		SHEET <b>1 OF 1</b>	

