

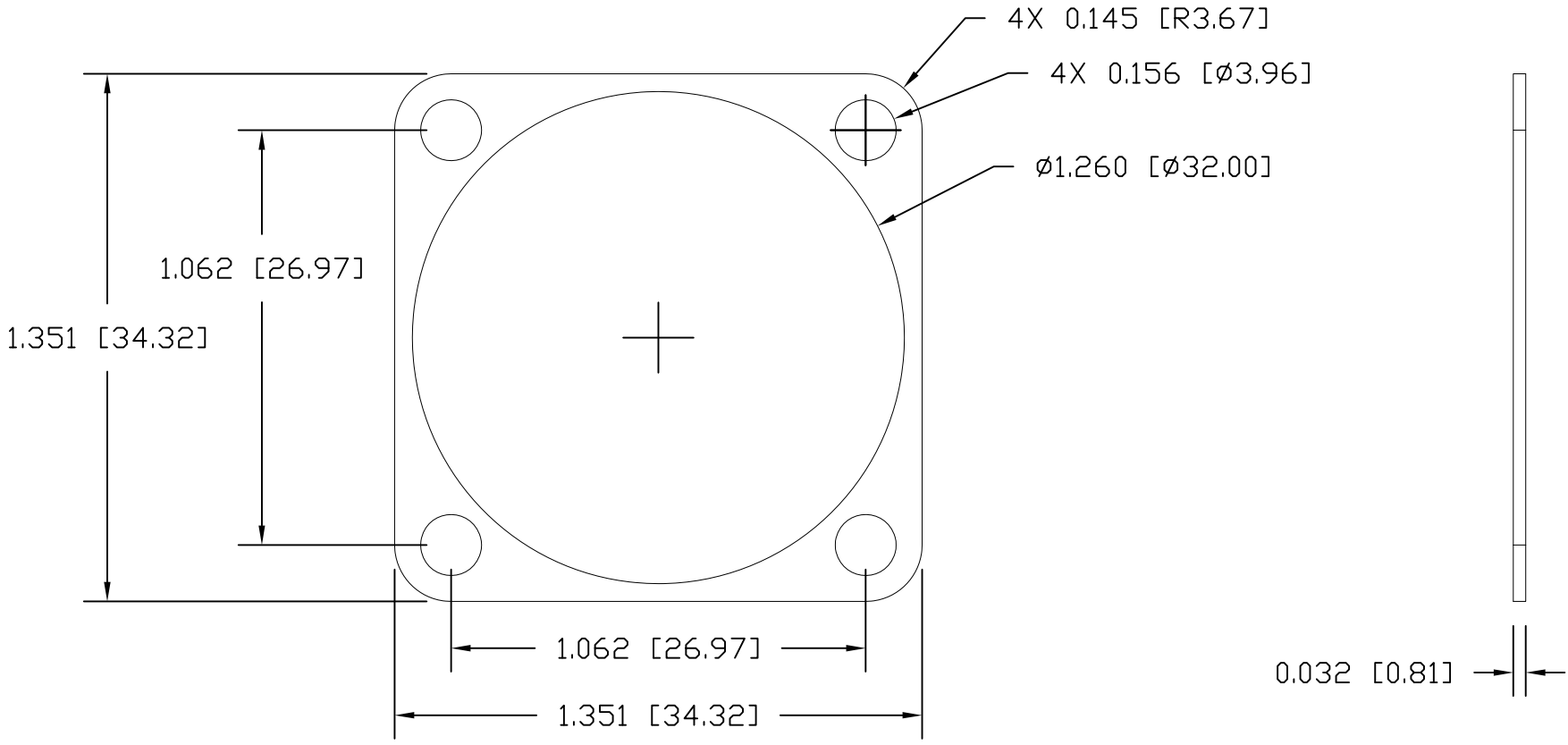

REVISIONS				
ZONE	REV	DESCRIPTION	DATE	APPROVED



Tolerances: Hole to Hole Centerline : +/- 0.010" Center Hole Diameter : + 0.020" / -0.0" Overall outside : +/- 0.015" Mounting Hole Diameter : +/- 0.010"	DRAWN	DATE
	S.ACKERMAN	2Q2015
	CHECKED	
	QA	
	MFG	
	APPROVED	

		252 Brighton Road, Andover NJ 07821 PH: 973-786-5000 FAX: 973-786-5546	
CONNECTOR GASKET			
SIZE	CAGE	DWG NO.	REV
A	27565	M83528/004X016	F
SCALE	SHEET		1 OF 1

