

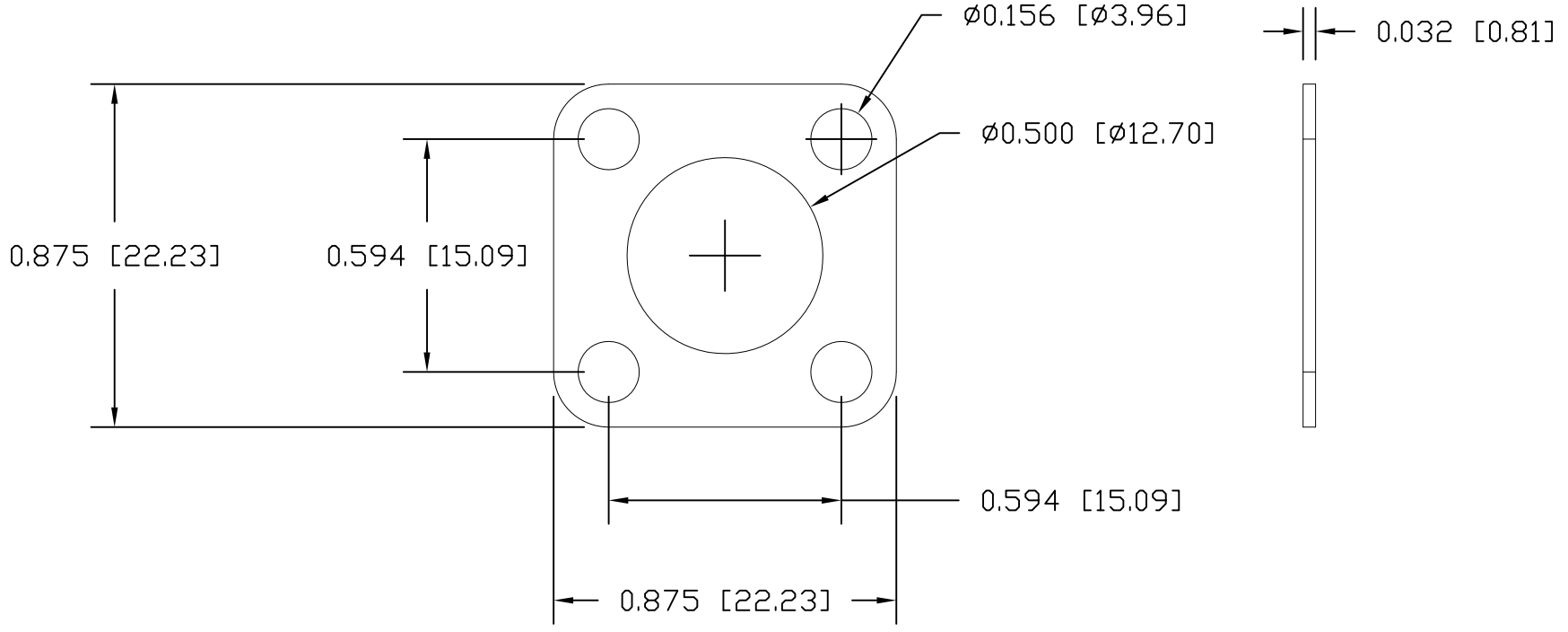

REVISIONS				
ZONE	REV	DESCRIPTION	DATE	APPROVED



<b>Tolerances:</b> Hole to Hole Centerline : +/- 0.010" Center Hole Diameter : + 0.020" / -0.0" Overall outside : +/- 0.015" Mounting Hole Diameter : +/- 0.010"	DRAWN	DATE
	S.ACKERMAN	2Q2015
	CHECKED	
	QA	
	MFG	
	APPROVED	

		252 Brighton Road, Andover NJ 07821 PH: 973-786-5000 FAX: 973-786-5546		
		<b>CONNECTOR GASKET</b>		
SIZE	CAGE	DWG NO.	REV	
<b>A</b>	27565	M83528/004X004	<b>F</b>	
SCALE	SHEET		1 OF 1	

