

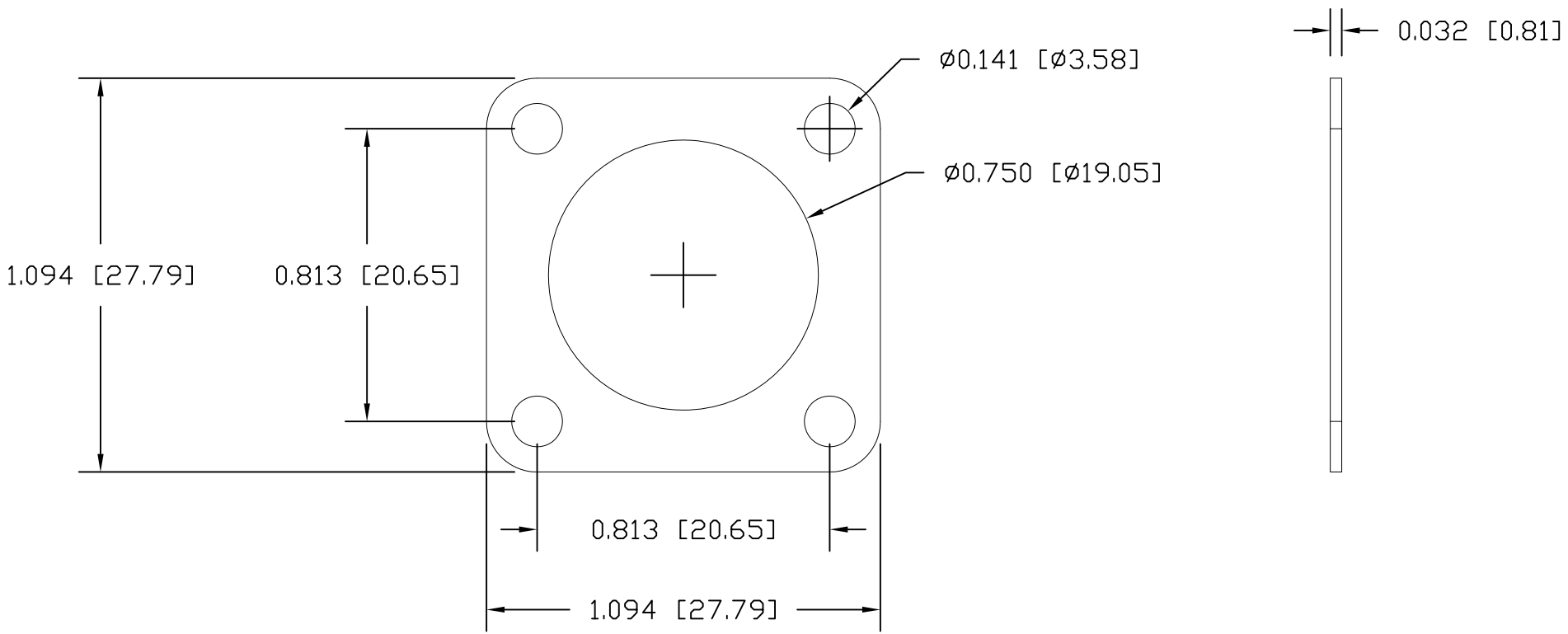



REVISIONS				
ZONE	REV	DESCRIPTION	DATE	APPROVED



Tolerances: Hole to Hole Centerline : +/- 0.010" Center Hole Diameter : + 0.020" / -0.0" Overall outside : +/- 0.015" Mounting Hole Diameter : +/- 0.010"	DRAWN S.ACKERMAN	DATE 2Q2015	 252 Brighton Road, Andover NJ 07821 PH: 973-786-5000 FAX: 973-786-5546			
	CHECKED				CONNECTOR GASKET	
	QA					
	MFG		SIZE A	CAGE 27565	DWG NO. M83528/004X009	REV F
	APPROVED		SCALE		SHEET 1 OF 1	

